

Magnetic track Installation Manual



To users: Thank you for buying our products! Please read the instruction carefully and keep it for reference before using it. To ensure safe construction, please confirm the following important items before starting work

- ⚠ Warning: improper use may lead to personal accidents
 ⚠ Attention: improper use may cause material damage
⊘ : Forbidden items
 ⚡ : Compliance items

Before installation

- This product is a special indoor lamp for the common environment. The following environmental conditions are not available.
- Ambient temperature below -10°C and above 50°C;
- Ceilings that cannot bear the weight of lamps and lanterns;
- Wet place, humidity > 80% PH;
- Dust, where corrosive gases occur;
- Where the ceiling is insulated;
- Space required for magnetism in hospitals, operating rooms, etc;
- If you have difficulty in judging the use environment, please contact us service department;
- Where the air conditioner or tuyere is located;
- Inclined, concave and convex ceilings;
- Places with direct sunlight;
- Places of shock and shock;
- Outdoor;

Lighting wiring

- Be sure to have relevant qualification certificates for installation by engineers; (Risk of a safety accident)
- The magnetic suction track needs to be equipped with a 48V DC switching power supply, which can not be directly connected with the municipal electricity;
- Lighting and other power lines (such as air conditioning or high-power electric equipment) are separated;

Lighting installation

- Before maintaining and installing the lamps, make sure that the power supply has been cut off and that the connection is correct before turning on the power supply; (Risk of electric shock)
- Please do not decompose or alter the lamps; (Risk of electric shock, fire, fall, malfunction)
- When the lights are on or off, the lamps are in a high temperature state, Do not touch the lamps; (Risk of scald)
- Do not wet your hands for installation; (risk of electric shock)
- There should be no strong alternating magnetic field around the lamp;
- The built-in magnet structure of the lamp has great attraction. When the track is put into the lamp, beware of pinch injury;
- The safety buckle should also be put in place when the lamps and lanterns are put on the track; (Risk of falling lamps)

Lighting installation

- The actual power of the product ranges from 90% to 110% of the nominal power. (The load current carrying capacity of the wires should be considered in the construction wiring.)
- The force point of the ceiling in the lighting installation area must be more than four times the weight of the lamps; (Risk of Fall and Failure)
- The lamp can not be used in violation of any fire protection regulations; (Fire risk)
- Non-user-replaced light source: The light source in this lamp shall be replaced by the manufacturer or its service agent or someone with similar qualifications; (Risk of product failure)
- If you feel the abnormal situation of smoke and odor, please cut off the power immediately and consult the construction party; (Fire risk)

When abnormal phenomenon occurs, please cut off the power supply quickly, contact our customer service department or check, repair and replace by professional qualified personnel.

Place of use: office, exhibition hall, exclusive store, hotel, villa, club and other space.

Track Specification/Dimension/Parameters

<p>Surface mounted/Pendant/Track</p>	<p>Magnetic track standard length: 0.5m/1.0m/1.5m/2.0m</p>	
<p>Recessed track with wings</p>		
<p>Recessed track with high wings</p>		
Load voltage		DC48V
Load current		Up to 16A per track
Load power		768W
Splicing length	The best connection of the track is ≤40 meters	
Product color	Black / white	
Standard Length	0.5m/1.0m/1.5m/2.0m	
product Category	III	
Life span	10 years	

I.Magnetic Track connection legend

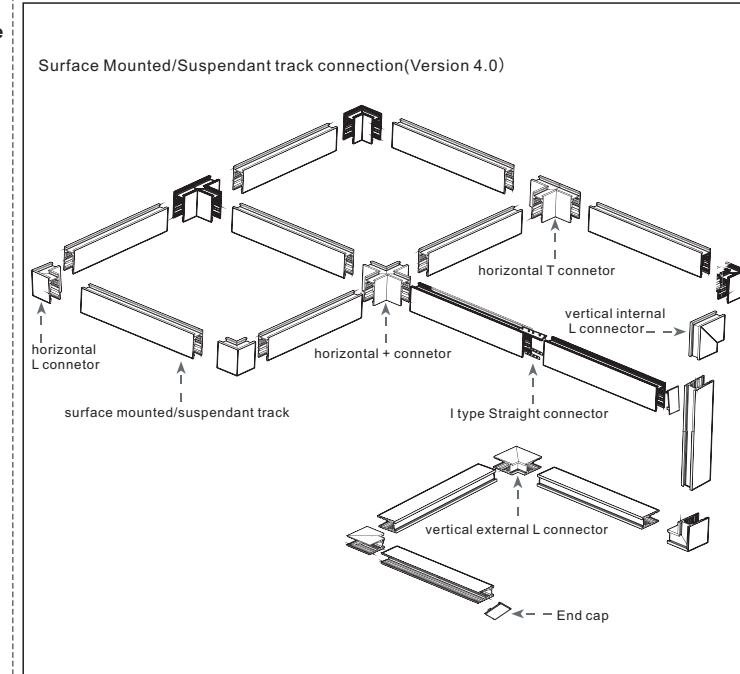

Recessed track connection (Version 4.0)

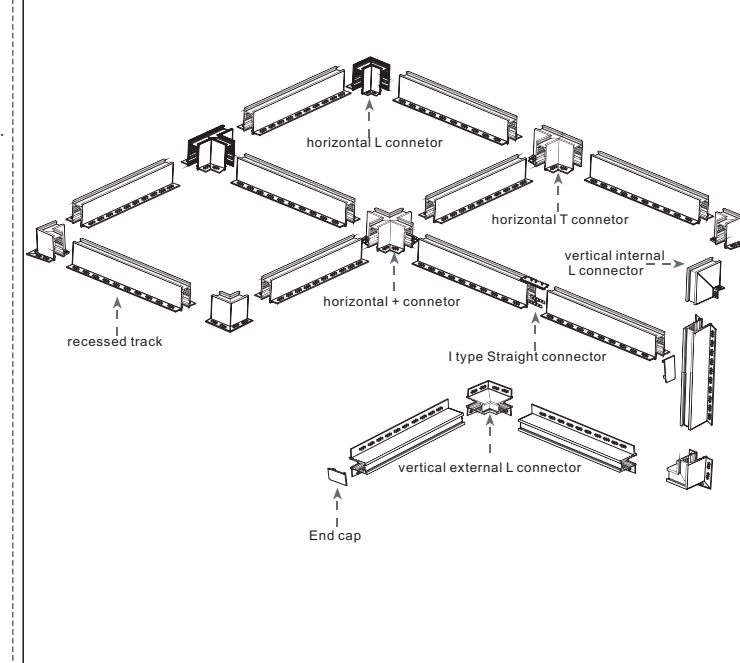

II.Magnet track connection instruction

Straight type connection

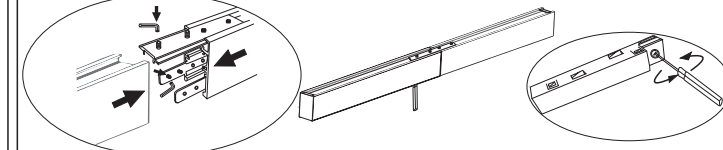

1. Fixed I type connector with screwing the safety buckle between the tracks gap, test and ensure the track on powered.

horizontal L connection:

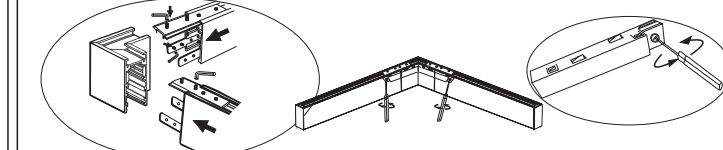

2. Fixed L type connector with screwing the safety buckle between the tracks gap, test and ensure the track on powered.

vertical internal L connection:

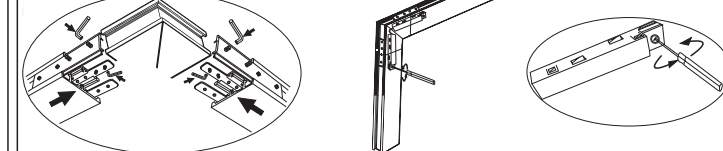

3. Fixed internal L type connector with screwing the safety buckle between the tracks gap, test and ensure the track on powered.

vertical external L connection:

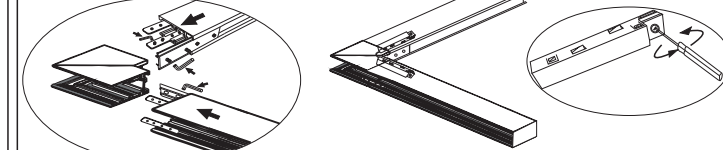

4. Fixed external L type connector with screwing the safety buckle between the tracks gap, test and ensure the track on powered.

T connection:

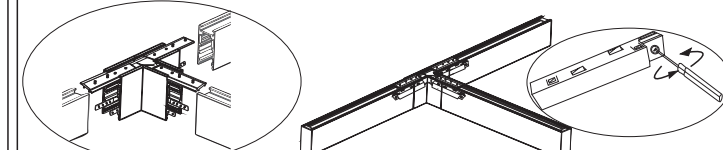

5. Fixed T type connector with screwing the safety buckle between the tracks gap, test and ensure the track on powered.

+ connection:

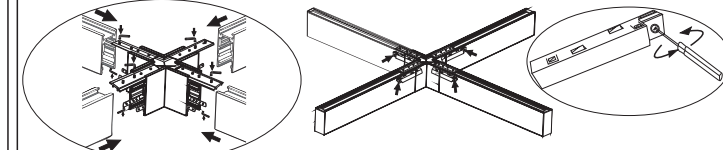

6. Fixed + type connector with screwing the safety buckle between the tracks gap, test and ensure the track on powered.

III. Magnetic track accessories installation

It is necessary to know that the following accessories are used for rail assembly/ installation. Please check them carefully.

NO.	Model	Picture	Description
1	L type horizontal track connector without wing		Only for surface mounted/pendent/recessed(without trim) track horizontal L corner splicing, black/white/optional purchase
2	without wing L type inner vertical track connector		For L type inner vertical corner splicing, black/white/optional purchase
3	L type outer vertical track connector without wing		For L type outer vertical corner splicing, black/white/optional purchase
4	T type horizontal track connector without wing		Only for T type corner splicing recessed track without wing black/white/optional purchase
5	+ type horizontal track connector without wing		Only for + type corner splicing recessed track without wing black/white/optional purchase
6	L type horizontal track connector with wing		Only for L type horizontal corner splicing track with wing black/white/optional purchase
7	L type inner vertical track connector with wing		Only for L type inner vertical corner splicing track with wing black/white/optional purchase
8	L type outer vertical track connector with wing		Only for L type outer vertical corner splicing track with wing black/white/optional purchase
9	T type horizontal track connector with wing		Only for T type horizontal recessed track connector with wing black/white/optional purchase
10	+ type horizontal track connector with wing		Only for + type horizontal recessed track connector with wing black/white/optional purchase
11	L type horizontal track connector with high wing		Only for L type horizontal recessed track connector with high wing black/white/optional purchase
12	L type inner vertical track connector with high wing		Only for L type inner vertical recessed track connector with high wing black/white/optional purchase
13	L type outer vertical track connector with high wing		Only for L type outer vertical recessed track connector with high wing black/white/optional purchase
14	T type horizontal track connector with high wing		Only for T type horizontal recessed track connector with high wing black/white/optional purchase
15	+ type horizontal track connector with high wing		Only for + type horizontal recessed track connector with high wing black/white/optional purchase
16	Straight connector track fixed kit		For the connect and fix use of any track 1 PCS for each segment splicing/optional purchase

NO.	Model	Picture	Description
17	4.0 Power feeder		Option for conductive linear connection of track 1PCS for each power
18	I power connector		Option for conductive linear connection 1PCS for each segment splicing
19	L type horizontal inner track connector		Use for horizontal 90° connector 1PCS for each segment splicing
20	L type vertical outer track connector		Use for vertical 90° connector 1PCS for each segment splicing
21	T type track connector		Use for T type track 1PCS for each segment splicing
22	+ type track connector		Use for + type track 1PCS for each segment splicing
23	Magnetic track PC Cover		For track through without lamp position cover, black/white/optional purchase
24	End cap		Used for installation of end caps at both ends of track, black/white/optional purchase

IV. installation of external power supply for magnetic track (suitable for any brand of external 48V output constant voltage switching power supply)

Wiring instructions for external magnetic absorption track of power supply:

1. Thread the 4.0 conductive connector wire out of the track outlet hole, then clip the 4.0 conductive connector into the track, and tighten the safety buckle on the 4.0 conductive connector with a slotted screwdriver,
2. Put the external drive power supply on the ceiling and connect the line, and connect the output line with the 4.0 conductive connector line.

Note: refer to chart 4.1 and chart 4.2 / chart 4.1 for wiring mode Ensure that the track is completely and firmly installed;

Chart 4.1

Ceiling plank (note: plank installation requirements are 8-15mm)

Table 4.1

NO.	Color	Power wire instructions
1	Brown	AC220V input, connect L wire
2	Blue	AC220V input, connect N wire

Table 4.2

NO.	Color	Function indication of power wire and signal wire installation wiring
1	Red	Switch power supply output 48V+
2	Black	Switch power supply output 48V-
3	Blue	Connect the positive pole of the signal wire (Non-dimming is negligible)
4	White	Connect the negative pole of the signal wire (Non-dimming is negligible)

V.Surface Mounted track installation

Surface mounted track accessories(option/necessity)

Item	Picture	Size/mm	Description
Surface mounted track fast fixing buckle			To fix surface mounted track

Installation steps:

1. Please refer to the chart 5.1 before installation hole size and distance for quick fix and install. Chart 5.1

Installation accessories size spacing table

Table 5.1

Track Model/Length	A Spacing	B Spacing	C Spacing	D Spacing	E Spacing	F Spacing	Surface mounting fittings
0.5m	67mm	365mm	/	/	/	/	2pcs
1.0m	67mm	433mm	433mm	/	/	/	3pcs
1.5m	67mm	455mm	455mm	455mm	/	/	4pcs
2.0m	67mm	373mm	373mm	373mm	373mm	373mm	6pcs

Chart 5.1

2. Install the fixing buckle along the line which was drawn for the track position, and leave an outlet hole on the ceiling. Chart 5.2

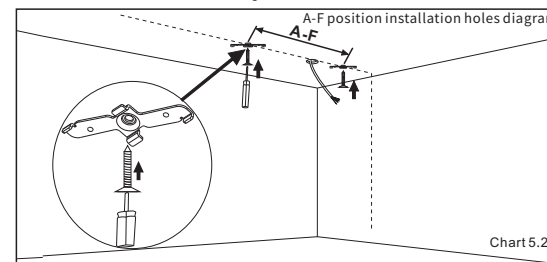

3. Connect the power supply with the end of the track outlet, fixed security buckle and connect with the ceiling cable well. Chart 5.3

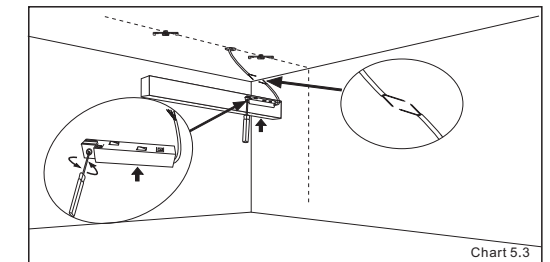

4. Align the track back slot with the fast fixing buckle, insert the fixing buckle clockwise into the slot, double check and make sure it is enough stable. Chart 5.4

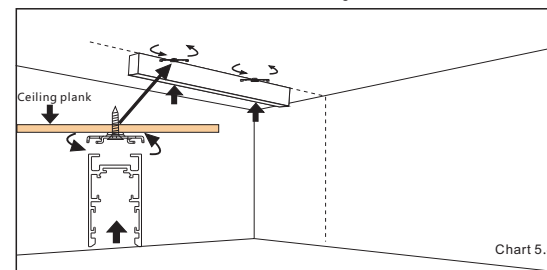

5. Put the magnetic track and light on powered, if working well, installation done. Chart 5.5

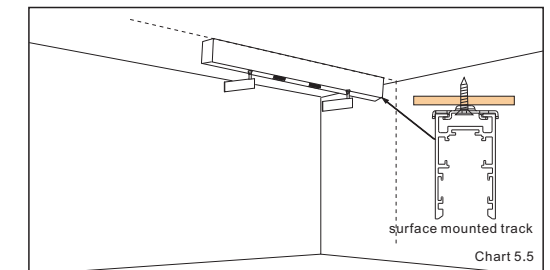

VI. Suspended Track Installation/Suspension Wire Type

Pendent track installation accessories (necessary)

Model NO. / Name	Picture	Size(mm)	Descriptions
Suspension Wire			Used for suspension wire installation/wire standard 1.5m (the length of rod is available on request) necessary

Installation steps:

1. Before installation, please refer to the hole location diagram and hole size spacing table (Chart 6.1 and Table 6.1), and then go to the installation area to locate. For the 4.0 vision conductive connector installation, please refer to the external power supply installation (Chart 4.1).

A-D position installation holes diagram

Chart 6.1

Installation accessories size spacing table

Table 6.1

Track Model/Length	A Spacing	B Spacing	C Spacing	D Spacing	Quantity of suspension accessories
0.5m	67mm	365mm	/	/	2pcs
1.0m	67mm	865mm	/	/	2pcs
1.5m	67mm	683mm	683mm	/	3pcs
2.0m	67mm	622mm	622mm	622mm	4pcs

2. In the track installation area, marks the straight line to determine a location to install the suspension wires (Chart 6.2)

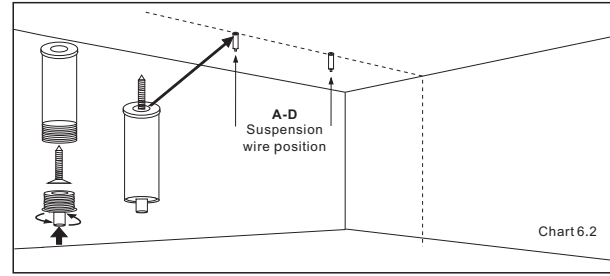

Chart 6.2

3. Install the suspension wires and fixed plate to the marked location, check whether the installation is firmed (Chart 6.3)

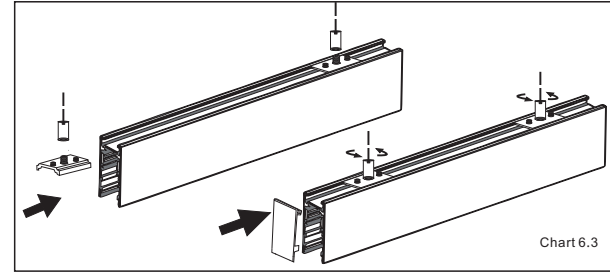

Chart 6.3

4. Lift the track, hold the locks of suspension accessories, then insert the wires into the locks and adjust them to a proper height, finally check whether the track is firmly installed (Chart 6.4)

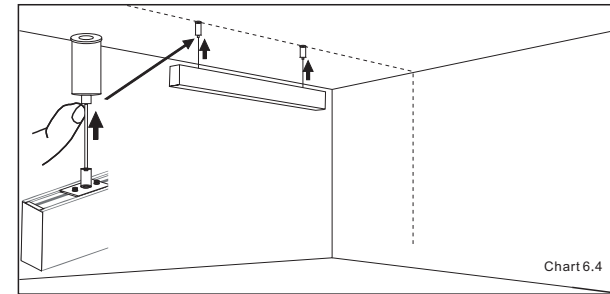

Chart 6.4

5. put the magnetic track and light on powered, if working well, installation done (Chart 6.5)

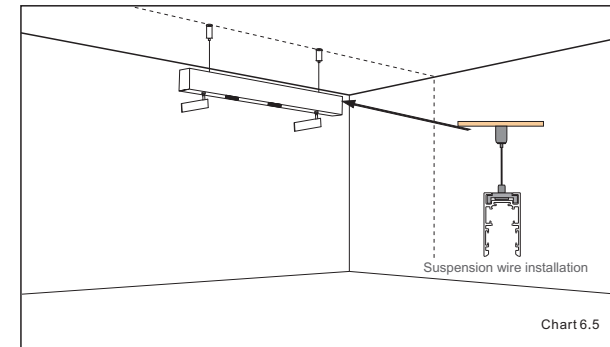

Chart 6.5

VII. Pendant Track Installation/Suspension Rod Type

Pendant track installation accessories (necessary)

Model NO. / Name	Picture	Size(mm)	Descriptions
Suspension Rod			Optional suspension rod: 0.5m/1m Scalable suspension rod: 0.25-0.5m/0.5-1m Black/white/optional (the length of rod is available on request)

Installation steps:

- Before installation, please refer to the pendant position picture and table (Chart 6.1 and Table 6.1). about the version 4.0 conductive connector installation, please refer to the external power supply installation (Chart 4.1).
- In the track installation area, marks the straight line to determine a location to install the suspension rods (Chart 7.1)
- Assemble the suspension rod and the ceiling box, then fix them to the track, tighten the screws of the rod and track, check whether the height is in the same position (Chart 7.2);

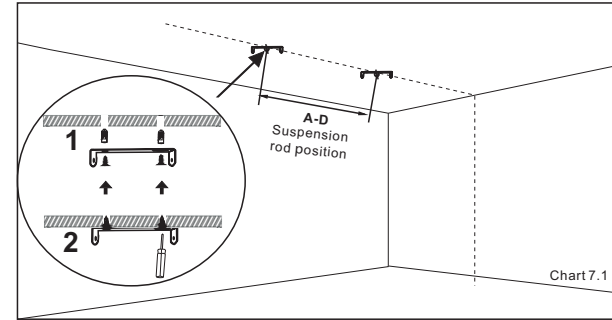

Chart 7.1

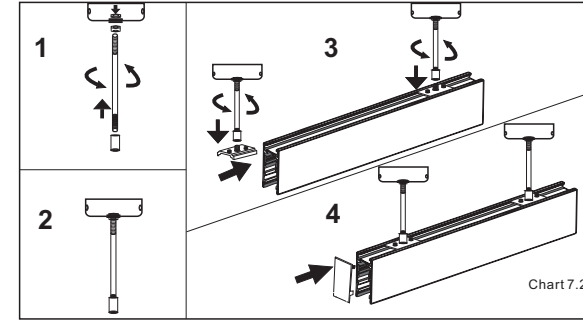

Chart 7.2

4. Hold the track, cover the ceiling bracket with the ceiling box, align the side screws hole, and then fix the screws, check whether the installation is firmed (Chart 7.3)

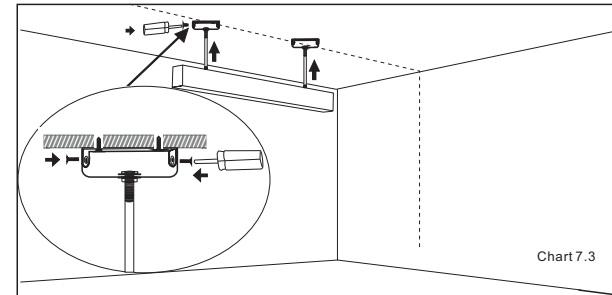

Chart 7.3

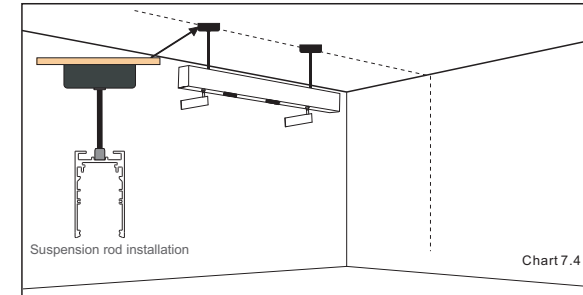

Chart 7.4

5. put the magnetic track and light on powered, if working well, installation done (Chart 7.4)

VIII. Recessed Track(With Wings) Installation

Recessed track (with wings) installation accessories (necessary)

Model NO. / Name	Picture	Size(mm)	Descriptions
Model: 4*30 Self-tapping screws		4*30	Used for fixing the recessed track Track standard

Installation steps:

- Before installation, please refer to the cut out size (Table 8.1) and screws position (Chart 8.1), and then go to the installation area to locate the hole. For the conductive connector installation, please refer to the external power supply installation (Chart 4.1).

Cut out size of the recessed track (with wings) Table 8.1

Model/Length	Cut out size(L×W×H)	Quantity of self-tapping screws
0.5m	510×35×60mm	6pcs
1.0m	1010×35×60mm	12pcs
1.5m	1510×35×60mm	18pcs
2.0m	2010×35×60mm	24pcs

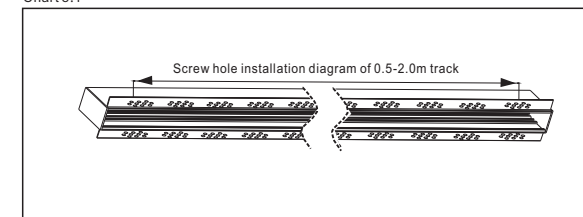

Chart 8.1

2. Before cut the hole(cutout size, refer to table 8.1), please marks the cutout location. Chart 8.2

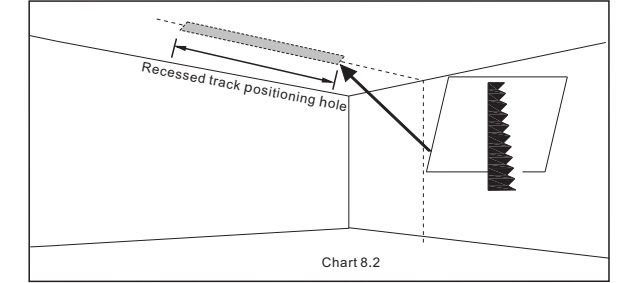

Chart 8.2

3. Insert the track into the ceiling, fix two sides of the track with self-tapping screws, then check whether the installation is firmed (Chart 8.3)

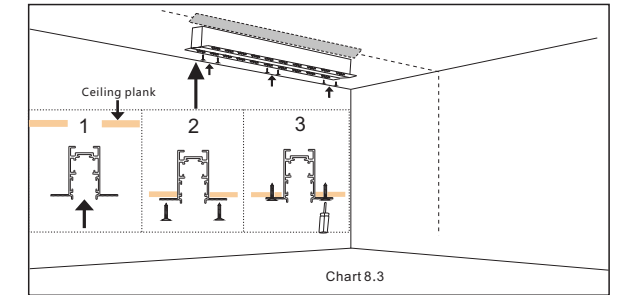

Chart 8.3

4. Covering the track edge with lime (Chart 8.4)

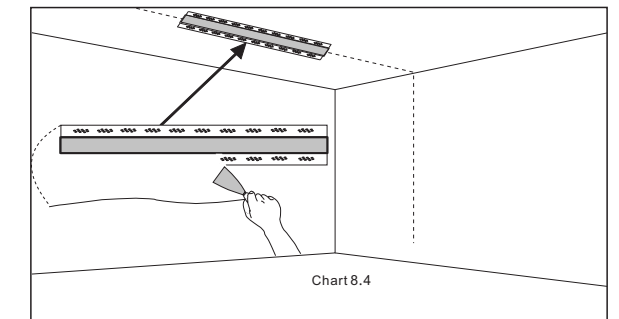

Chart 8.4

5. put the magnetic track and light on powered, if working well, installation done (Chart 8.5)

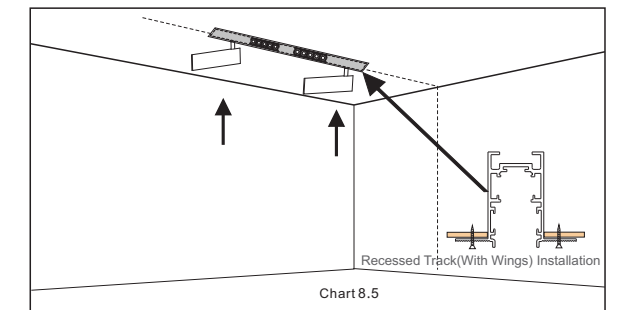

Chart 8.5

IX. Recessed Track (With High Wings) Installation

Recessed track (with high wings) installation accessories (necessary)

Model NO. / Name	Picture	Size(mm)	Descriptions
Model: 4*30 Self-tapping screws		4*30	Used for fixing the recessed track Track standard

Installation steps:

1. Before installation, please refer to the cut out size (Table 9.1) and screws position (Chart 9.1), and then go to the installation area to locate the hole. For the conductive connector in stallation, please refer to the external power supply installation (Chart 4.1).

Table 9.1
Cut out size of the recessed track (with high wings)

Model/Length	Cut out size(L×W×H)	Quantity of self-tapping screws
0.5m	510×35×60mm	6pcs
1.0m	1010×35×60mm	12pcs
1.5m	1510×35×60mm	18pcs
2.0m	2010×35×60mm	24pcs

2. Before cut the hole (cutout size, refer to table 9.1), please marks the cutout location. Chart 9.2

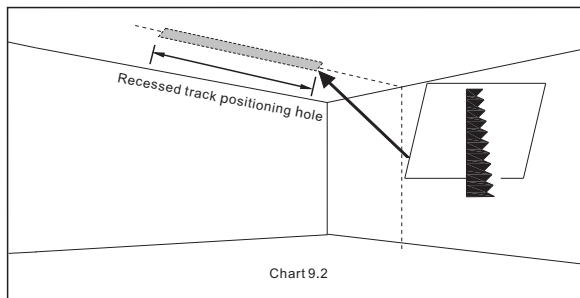

4. After fixing the track, cover two sides of the track with a 12mm plasterboard or plank (Chart 9.4).

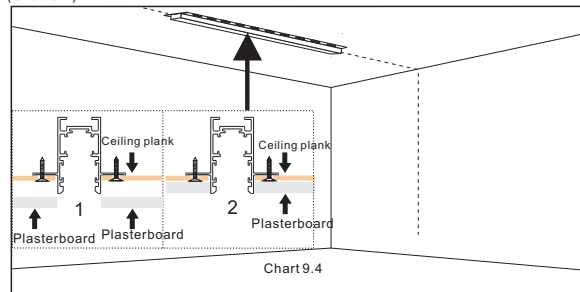

6. put the magnetic track and light on powered, if working well, installation done (Chart 9.6).

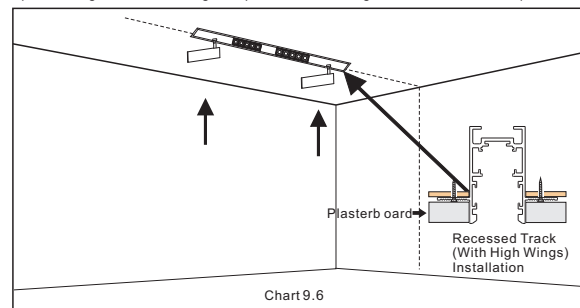
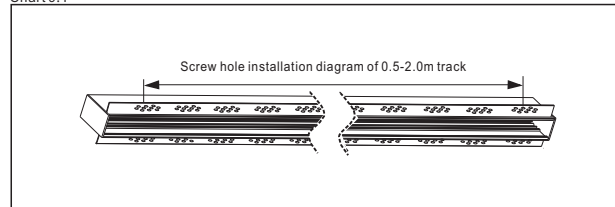
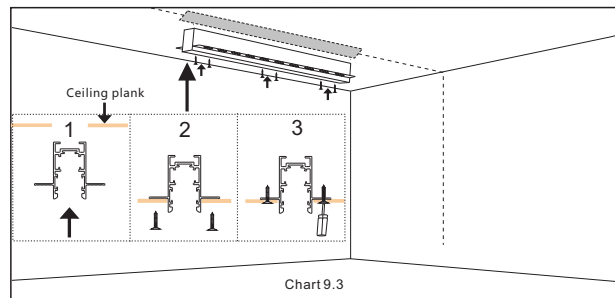

Chart 9.1



3. Insert the track into the ceiling, fix two sides of the track with self-tapping screws, then check whether the installation is firmed (Chart 9.3).



5. Covering the track edge with lime (Chart 9.5).

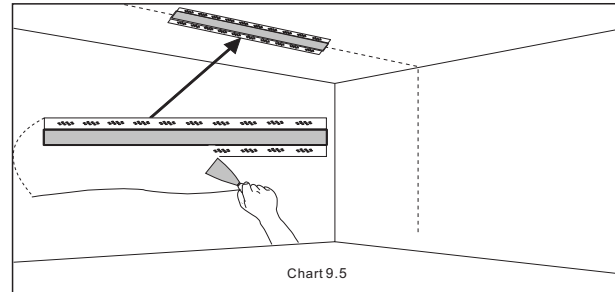

X. Magnetic track PC Cover Installation Suitable for all series of tracks

PC cover installation accessories (necessary)

Model NO. / Name	Picture	Descriptions
PC Cover		Used for track grooves without light PC cover standard length 1m Black/white/optional

Installation steps:

1. After installing the track and the lights, are installed, the area of the track is not installed, use PC cover to cover the track area where is not installed to make the track more safer and beautiful (As shown below).

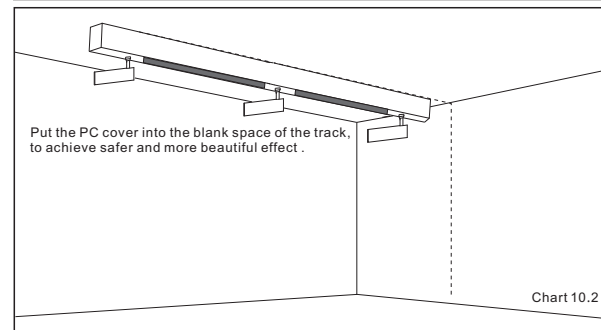
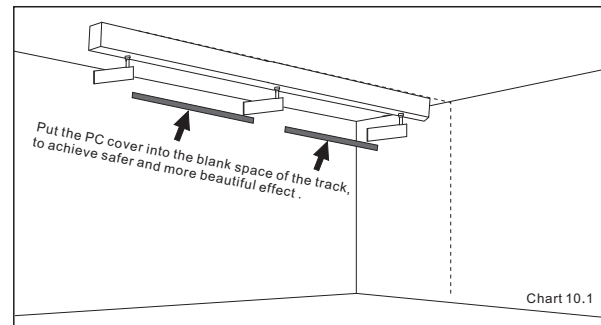

XI. Description of magnetic suction rail rubber plug

All magnetic suction tracks are protected by rubber plugs to prevent deformation, installation attention instructions:

1. Track installation, protect the rubber plug do not remove, after the completion of track installation pull out the rubber plug; rubber plug can prevent track deformation.

